

SCIENTEMP CORP.

Medical Freezers ~ Pharmacy Freezers ~ Culture Storage Freezers ~ Blood Storage/Blood Plasma Freezers
Adhesive Storage Freezers ~ Industrial/Manufacturing Freezers ~ Flammable and Explosion Proof Freezers

Your Scientemp freezer has been pre-programmed at the factory and ready for use. You only have to:

- 1) Plug your freezer into its own dedicated circuit and
- 2) Set your desired temperature on the controller

Setting SP1 and SP2

- Press and release SET. The current value of order 1 is displayed. SP1 (freezer set point) and led OUT 1 blink.
- Press UP or DOWN to increase or decrease the value.
- Press SET to confirm the new value. The actual value of order 2 will be displayed, SP2 (freezer alarm set point) and LED OUT 2 blink.
- Press UP or DOWN to increase or decrease the value.
- Press SET to confirm the new value and exit.

- Provide at least 3” of space around the freezer for ventilation. Avoid placing the freezer in locations exposed to direct sunlight, heat registers or any other heat source.
- Alarm On/Off switch should remain in the “Off” position until the freezer reaches desired set point temperature. When the temperature has been reached, turn the alarm switch to the “On” position.
- Cabinet should not be loaded with product until the cabinet has operated for 24 hours at the desired set point temperature.

Maintenance tips for your Scientemp Freezer:

- Regularly remove any frost build up by using a plastic/wooden scraper.
- Check and replace batteries on Chart Recorder (if equipped) on a regular bases.
- The black tube condenser on the back of the freezer, should be cleaned of dust and debris about once a year (or more often if freezer is located where excessive dust and dirt may occur)

~~This can be done by vacuuming carefully or by using forced air to blow the debris off.

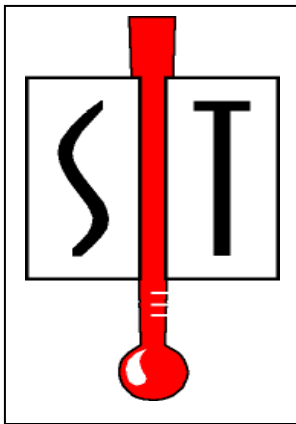

Scientemp Corp.

3565 S. Adrian Hwy
Adrian, Michigan 49221

Phone: 517-263-6020

Fax: 517-263-5492

Website: www.scientemp.com

OPERATING AND INSTALLATION MANUAL MODEL 34-20A

This cabinet has passed the
QUALITY CONTROL INSPECTION
and meets the high standards at Scientemp Corp.
This inspection includes the complete refrigeration
system, cabinet construction and finish.

CONTACTING FACTORY

For reference and when contacting the factory, please have your freezer information ready:

MODEL NUMBER: _____

SERIAL NUMBER: _____

DATE SHIPPED: _____

PURCHASED FROM: _____

The Model Number and Serial Number can be found on the data plate attached to the cabinet on the back upper left corner.

**SCIENTEMP CORP.
3565 S. ADRIAN HIGHWAY
ADRIAN, MICHIGAN
49221**

**TELEPHONE: 517-263-6020
FAX: 517-263-5492**

**Sales Contacts:
Tracy Proffitt
517-263-6020 Ext. 104
tracy@scientemp.com**

**Kelli Wadke
517-263-6020 Ext. 102
kelli@scientemp.com**

Web site: www.scientemp.com

Before you get started, please take a few minutes to read through this manual.

1. MOVING YOUR FREEZER

The refrigeration system of the cabinet is designed to operate with the cabinet located on a flat surface. **Do not tilt the cabinet more than 30° to any side.** If the cabinet must be tilted on an angle for handling or moving purposes allow it to sit in an upright position for at least two (2) hours prior to starting.

2. SAFETY PRECAUTIONS

In this manual, the words **WARNING** and **CAUTION** mean the following:

***WARNING:** a potentially hazardous situation, which if not avoided, could result in serious injury or death.

***CAUTION:** a potentially hazardous situation, which if not avoided, may result in minor or moderate injury or damage to equipment.

Before installing, using or maintaining this product, please be sure to read this manual carefully. Failure to follow these instructions may cause this product to malfunction, which could result in injury or damage.

Below are important safety precautions that apply to this product:

- Use this product only in the manner described in the product literature and in this manual. Before using it, verify that this product is suitable for its intended use.
- Do not modify system components.
- The cabinet must be properly grounded in conformity with national and local electrical codes. Never connect the unit to overloaded power sources.
- Disconnect the unit from all power sources before cleaning, troubleshooting or performing other maintenance on the cabinet.

3. CHOOSING A LOCATION

3.1 Air Circulation

The cabinet should be situated to allow proper air circulation in a well ventilated room. Provide at least 3” of space around the freezer for ventilation. Avoid placing the freezer in locations exposed to direct sunlight, heat registers or any other heat sources.

***NOTE:** The cabinet must be installed on a sturdy, solid, level floor resting firmly on all four mounting points.

3.2 Ambient Temperature

Do not place cabinet in sunlight, near heating diffusers, radiators or other sources of heat. Drafts from fans, air conditioning or open doors can also affect the product temperature. The ambient temperature range at the location must be 59 to 90°F (15 to 32°C).

***Warning:** This unit is not a “rapid-freeze” device. Freezing large quantities of liquid or high water content items will temporarily increase the compressors to operate for prolonged periods of time. Attempting to utilize this freezer improperly may jeopardize safety or cause undue stress or damage to the refrigeration compressors.

Avoid opening the door for extended periods of time since chamber air will escape rapidly. Room air, which is higher in humidity, will replace chamber air and may cause frost to develop in the chamber more rapidly.

4. CHECK OUT YOUR NEW FREEZER

4.1 Lid Seal

If the lid gasket does not seal along the front edge, relieve the compression of the gasket along the back edge by loosening the hinge screws where they attach to the cabinet. Raise the lid slightly and then retighten the screws.

4.2 Interior Compartment Temperature

The temperature is controlled by a LOVE digital temperature controller. Set the control to the desired set point. Freezers are shipped from the factory with the indicating digital control programmed for proper operation. All but the temperature settings may be adjusted.

SETTING SP1 (TEMPERATURE SET POINT) AND SP2 (ALARM SET POINT)

1. PRESS AND RELEASE SET. THE CURRENT VALUE OF SP 1 IS DISPLAYED.
2. SP1 AND OUT 1 BLINK. PRESS UP OR DOWN TO INCREASE OR DECREASE THE VALUE.
3. PRESS SET TO CONFIRM THE NEW VALUE. THE ACTUAL VALUE OF SP 2 IS DISPLAYED.
4. SP2 AND OUT 2 WILL BLINK. PRESS UP OR DOWN TO INCREASE OR DECREASE THE VALUE.
5. PRESS SET TO CONFIRM THE VALUE AND EXIT.

NOTE: It is recommended to keep the freezer operating continually rather than turning the freezer off and on.

4.3 Frost removal

1. While the freezer is running, the frost may be removed with a plastic or wooden scraper or spatula. Do not use metal or sharp objects such as an ice pick, as this will cause serious damage to the finish of the inner-liner of the freezer. The frost and ice may be collected in a pan, towel or any device to prevent it from falling to the bottom of the freezer or onto the material stored in the freezer. Most of the frost and ice collects near the top edge and is easily removed.
2. In the case where the freezer is not loaded, frost and ice may be removed by disconnecting the power until the frost and ice thaw. After defrosting, dry the freezer compartment interior and plug freezer back in.

5 ELECTRICAL CONNECTIONS

5.1 Wiring

This cabinet is equipped with a three-prong (grounding) plug for your protection against shock hazards. The cabinet should be plugged directly into a properly grounded three-prong receptacle.

Where a two-prong wall receptacle is encountered, it must be replaced in accordance with the National Electronic Code and local codes and ordinances. A licensed electrician must do the work.

The electrical outlet should not be controlled by a wall switch, which might be turned off accidentally.

***WARNING: Do NOT under any circumstances cut or remove the round grounding prong from the cabinet plug.**

***CAUTION:** For personal safety and trouble-free operation, this cabinet must be properly grounded before it is used. Failure to ground the equipment may cause personal injury or damage to the equipment. Always conform to the National Electrical Code and local codes. Do not plug in the cabinet to overloaded power lines.

Consult a licensed electrician if you have ANY doubt about the grounding of your wall receptacle. Only a licensed electrician can determine the polarization of your wall receptacle.

6 DANGERS OF A LOW TEMPERATURE FREEZER

Any temperature below 0° Centigrade or 32° Fahrenheit provides a potential condition to cause freezing of water or material containing water. Material containing water solutions of salt or sugar will freeze at a slightly lower temperature, depending on the content of the solution.

Because all warm-blooded creatures are composed of a great percent of water with salinity, they are subject to freezing whenever the body cells, parts or extremities reach temperatures below freezing.

6.1 When Skin Freezes

When your skin is exposed to subfreezing temperatures for an extended amount of time, it can freeze. Your blood vessels constrict in response to dropping temperatures. This reduces the flow of blood and, therefore, the amount of oxygen to the tissues. When water in these tissues freezes and forms ice crystals, cell structure is destroyed.

Tissue damage from cell death interrupts circulation in the smallest blood vessels. Blood clots form and blood flow is

further diverted away from the frozen tissue. At this point, your skin temperature drops and the injured area grows even colder.

The first sign of frostbite may be a slightly painful tingling sensation, which often is followed by numbness. Your skin may look pale, and feel hard, cold and numb.

In the event of frostbite, warming is vital. Carefully warm frost-bitten areas gradually. Place your hands directly on the skin of warmer areas of your body. If possible, immerse your hands in water that is slightly above normal body temperature (about 100°F or 37.8°C), or which feels warm to someone else, until your normal color returns. Do not use direct heat. Seek medical attention as quickly as you can.

***CAUTION: Wear protective clothing while either handling or coming in contact with inside of freezer. Hands should be dry and protected by using gloves. Insulated gloves are best for extended use when handling frozen product. Sleeves or arm-length insulated gloves should protect arms. Coats, insulated aprons, etc. should protect other parts of the body that may be exposed to the cold.**

3. Remove the lid from the cabinet and remove the four screws holding the upper portion of the hinge to the lid.
4. To reinstall the lid, reverse the above procedure.
5. Check the lid for alignment and the gasket for a proper seal. Use the slotted hinge holes to make any required adjustments.

7 REFRIGERATION COMPARTMENT

The refrigeration system of a Scientemp freezer is hermetically sealed. It requires no maintenance. However, in areas where excessive dust and dirt collect, the condenser on back of freezer must be kept clean. To clean the condenser, remove power to freezer. Use forced air and a vacuum to clean dirt and debris from the condenser and refrigeration compartment periodically.

7.1 Fan

The fan motor has lifetime lubrication. It requires no maintenance.

8 REMOVING & INSTALLING CABINET LID

***CAUTION: HINGES ARE SPRING LOADED**

1. Remove the two top and one-bottom screws holding the lower portion of the hinge to the cabinet.
2. While applying pressure to hold the hinge to the cabinet, remove the remaining bottom screw. Carefully let the spring tension lift the hinge from the cabinet.

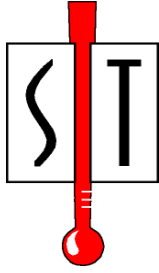

ScientempTM

3565 S. Adrian Hwy ♦ Adrian, MI 49221
800-968-2653 ♦ 517-263-6020 ♦ Fax 517-263-5492

Standard Warranty

Applies Only Within the Continental United States

SCIENTEMP WARRANTS TO THE ORIGINAL PURCHASER

FIRST 18 MONTHS – The cabinet and all of its parts shall be free of defects in material and workmanship under normal use and service for a period of 18 months from the date the unit has been shipped from our facility. Scientemp's sole obligation under this warranty shall be limited, at its option, to either repairing or replacing any part of the cabinet determined by an authorized service agent to be defective. Scientemp reserves the right to repair the freezer at our facilities.

THE SCIENTEMP STANDARD WARRANTY DOES NOT COVER

TRANSPORTATION COSTS – Scientemp shall not be responsible for transportation or incidental costs incurred in connection with the repair or replacement of a cabinet or any of its parts.

ABUSE, MISUSE, ACCIDENTS – Scientemp shall not be responsible for parts or assemblies which upon inspection are determined by an authorized Scientemp Service Agent to have been subjected to misuse, neglect, alteration, accident, abuse, damage during transit or delivery, or by fire or flood.

CONSEQUENTIAL DAMAGES – IN NO EVENT SHALL SCIENTEMP CORP BE LIABLE FOR SPECIAL, INDIRECT OR CONSEQUENTIAL DAMAGES, INCLUDING WITHOUT LIMITATION, PRODUCT LOSS OR PRODUCT SPOILAGE CLAIMS, NOR FOR ANY DELAY IN THE PERFORMANCE OF THIS WARRANTY DUE TO CAUSES BEYOND ITS CONTROL.

GENERAL

The standard warranty and any service contract related to the STANDARD WARRANTY shall apply only to the products sold and used within the boundaries of the Continental United States.

Users may file warranty claims either directly with Scientemp Corp, 3565 S. Adrian Hwy, Adrian, MI 49221, or with the seller from whom the cabinet was purchased. All claims must be supported by information concerning the alleged defect and specifically identified by the Serial Number of the cabinet.

THERE ARE NO OTHER WARRANTIES EXPRESS, IMPLIED, OR STATUTORY, EXCEPT THIS WARRANTY, WHICH IS IN LIEU OF ALL OTHER WARRANTIES INCLUDING TO THE EXTENT PERMITTED BY LAW, ANY IMPLIED WARRANTY OR MERCHANTABILITY OR FITNESS FOR A PARTICULAR PURPOSE.

DO NOT DRILL HOLES IN CABINET

Refrigeration tubing and wiring is routed through the cabinet walls. Leaks, wet insulation or electrical problems caused by drilling holes are not covered by warranty.

<u>LOVE TSS2 CONTROL CONFIGURATION</u>	<u>UNITS</u>	<u>VALUE</u>
SP1-SET POINT 1 (FREEZER TEMPERATURE)	DEGREES	-30
SP2-SET POINT 2 (ALARM SET POINT TEMPERATURE)	DEGREES	-24
RO-DEPENDENCY SP1,SP2	RANGE	IND
R1-DIFFERENTIAL FOR SP1	DEGREES	0.2
R2-DIFFERENTIAL FOR SP2	DEGREES	0.2
R3-BAND DIFFERENTIAL	DEGREES	0.2
R4-LOWEST VALUE FOR SP1	DEGREES	-99.9
R5-LOWEST VALUE FOR SP2	DEGREES	-99.9
R6-HIGHEST VALUE FOR SP1	DEGREES	99.9
R7-HIGHEST VALUE FOR SP2	DEGREES	99.9
R8-REGULATION OR OPERATING MODE	RANGE	ON1
A0-ALARM DIFFERENTIAL	DEGREES	0.3
A1- MAXIMUM ALARM PROBE 1	DEGREES	99.9
A2-MAXIMUM ALARM PROBE 2	DEGREES	99.9
A3-MINIMUM ALARM PROBE 1	DEGREES	99.9
A4-MINIMUM ALARM PROBE 2	DEGREES	99.9
A5-ALARM VERIFICATION TIME	H-M	0.1
C0-MINIMUM RELAY STOP TIME	MINUTES	0
C1-OPERATION RELAY 1	RANGE	DIR
C2-OPERATION RELAY 2	RANGE	DIR
C3- DEFAULT OPERATION RELAY 1	RANGE	CLO
C4-DEFAULT OPERATION RELAY 2	RANGE	CLO
P0-TEMPERATURE SCALE SELECTION	RANGE	C
P1- CALIBRATION OF PROBE 1	DEGREES	-1.5
P2-CALIBRATION OF PROBE 2	DEGREES	-1.5
P3-DECIMAL POINT	RANGE	YES
P4-PROBE TO BE DISPLAYED	RANGE	SD1
P5-NUMBER OF PROBES	RANGE	2
H0-REPROGRAMMING	RANGE	0
H1-KEYBOARD PROTECTION	RANGE	NO
H2-OPERATION LED OUT1	RANGE	DIR
H3-OPERATION LED OUT2	RANGE	DIR
H4-ADDRESS FOR SERIAL COMMUNICATION	NUMERIC	0
H5-ACCESS CODE TO PARAMETERS	NUMERIC	0

SETTING SP1 (TEMPERATURE SET POINT) AND SP2 (ALARM SET POINT)

PRESS AND RELEASE **SET**. THE CURRENT VALUE OF **SP 1** IS DISPLAYED.

SP1 AND **OUT 1** BLINK. PRESS **UP** OR **DOWN** TO INCREASE OR DECREASE THE VALUE.

PRESS **SET** TO CONFIRM THE NEW VALUE. THE ACTUAL VALUE OF **SP 2** IS DISPLAYED.

SP2 AND **OUT 2** WILL BLINK. PRESS **UP** OR **DOWN** TO INCREASE OR DECREASE THE VALUE.

PRESS **SET** TO CONFIRM THE VALUE AND EXIT.

PARAMETER SETUP

PRESS **SET** FOR 8 SECONDS. VALUE 0 BLINK.

WITH **UP** OR **DOWN** INPUT ACCESS CODE (FACTORY SET AS 0).

PRESS **SET** TO CONFIRM THE CODE. IF CORRECT THE, LABEL OF THE FIRST

PARAMETER WILL BE DISPLAYED. PRESS **UP** OR **DOWN** TO VIEW THE PARAMETER

FROM THE LIST. PRESS **SET** TO VIEW THE PARAMETER VALUE. PRESS **UP** OR **DOWN** TO

CHANGE THE VALUE. PRESS **SET** TO CONFIRM AND EXIT TO THE PARAMETER LIST.

PRESS **SET + DOWN** TO EXIT SETUP MODE OR WAIT ONE MINUTE.



Series TSS2 Dual Stage Temperature Switch

Specifications - Installation and Operating Instructions

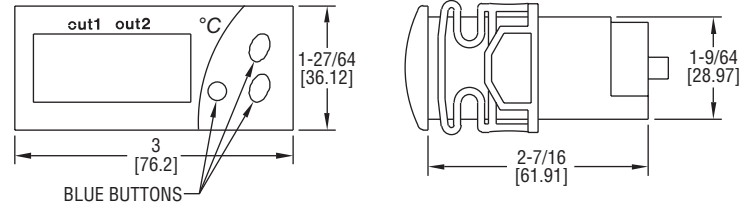

WIRING DIAGRAM

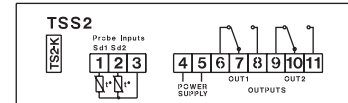

The **TSS2** is an electronic temperature controller designed for ON/OFF control or Neutral Area Control. They can be provided with 1 or 2 probes (PTC or NTC) according to parameter P5 and it provides two output relays plus an alarm buzzer. The unit controls cooling, heating or both, since its relays can be setup for direct or reverse operation. The user is able to program 34 different parameters including set points, hysteresis, configuration of alarms and probe adjustment using the silicone front keypad. The unit features error warning and password protection.

Each suffix can take the following values:

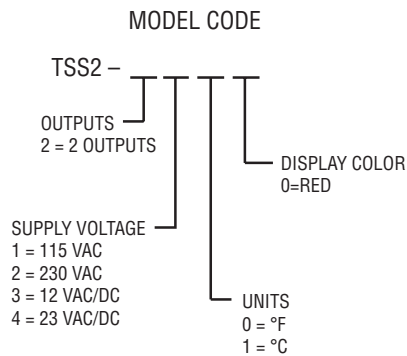

Note: Unit must be mounted away from vibration, impacts, water and corrosive gases.

- Cut hole in panel 71 x 29 mm (2.80 x 1.14 inches).
- Apply silicone (or rubber gasket) around the perimeter of the hole to prevent leakage.
- Insert unit into hole of panel.
- Slide removable fitting clips onto unit from the back until secure to panel.
- Wiring diagram is displayed on the top of the unit.
- **Note:** DO NOT INSTALL PROBE CABLE NEAR POWER CABLES.

SPECIFICATIONS

Probe Range:

PTC: -58 to 302°F (-50 to 150°C);
NTC: -58 to 230°F (-50 to 110°C).

Input:

PTC: 1000Ω @ 25°C;
NTC: 10 kΩ @ 25°C.

Outputs: OUT1 - SPDT relay rated 16A @ 240 VAC resistive; OUT2 - SPDT relay rated 8A @ 240 VAC resistive.

Horsepower Rating (HP): 1 HP (OUT1).

Power Requirements: 115 VAC, 230 VAC, 12 VAC/VDC or 24 VAC/VDC (depending on model).

Accuracy: 1% FS.

Display: 3-digit and sign, red LED.

Resolution: 0.1° (<100°); 1° (≥100°).

Memory Backup: Nonvolatile memory.

Temperature Limit: Ambient: 32 to 158°F (0 to 70°C).

Storage Temperature: -4 to 176°F (-20 to 80°C).

Dimensions: 3 x 1-27/64 x 2-7/16 in.

Front Panel Rating: IP64.

Weight: 2.3 oz (65 g).

Agency Approvals: CE, cURus.

Maintenance, cleaning and repair

After final installation of the unit, no routine maintenance is required. Clean the surface of the display controller with a soft and damp cloth. Never use abrasive detergents, petrol, alcohol or solvents. All repairs must be made by authorized personnel.

List of parameters

Parameter	Description	Units	Range
SP1	Set Point 1	Degrees	r4 to r6
SP2	Set Point 2	Degrees	r5 to r7
r0	Dependency SP1-SP2	Range	ind/dep
r1	Differential for SP1	Degrees	0.1 to 20.0
r2	Differential for SP2	Degrees	0.1 to 20.0
r3	Band differential	Degrees	0.1 to 20.0
r4	Lowest value for SP1	Degrees	-99.9 to r6
r5	Lowest value for SP2	Degrees	-99.9 to r7
r6	Highest value for SP1	Degrees	r4 to 302
r7	Highest value for SP2	Degrees	r5 to 302
r8	Regulation or operating mode	Range	On1/On2/nEU
A0	Alarm differential	Degrees	0.1 to 20.0
A1	Maximum alarm probe 1 (1)	Degrees	0.1 to 99.9
A2	Maximum alarm probe 2 (2)	Degrees	0.1 to 99.9
A3	Minimum alarm probe 1 (1)	Degrees	0.1 to 99.9
A4	Minimum alarm probe 2 (2)	Degrees	0.1 to 99.9
A5	Alarm verification time	h-m (*)	0.0 to 18.0
A6	Alarm probe 1 selection	Range	AHL/Ano/AH/AL
A7	Alarm probe 2 selection	Range	AHL/Ano/AH/AL
c0	Minimum relay stop time	Minutes	0 to 240
c1	Operation relay 1	Range	dir/inv
c2	Operation relay 2	Range	dir/inv
c3	Default operation relay 1	Range	Opn/Clo
c4	Default operation relay 2	Range	Opn/Clo
P0	Temperature scale selection	Range	°C/°F
P1	Calibration of probe 1	Degrees	-20.0 to 20.0
P2	Calibration of probe 2	Degrees	-20.0 to 20.0
P3	Decimal point	Range	no/yes
P4	Probe to be displayed	Range	sd1/sd2
P5	Number of probes	Range	1/2
H0	Reprogramming	Range	0
H1	Keyboard protection	Range	no/yes
H2	Operation LED OUT1	Range	dir/inv
H3	Operation LED OUT2	Range	dir/inv
H4	Address for serial communication	Numeric	0 to 999
H5	Access code to parameters	Numeric	0 to 999
H6	Probe type	Range	Ptc/Ntc

(*)h-m are data in format XX.Y where XX are hours and Y tens of minutes.

(1)referred to set 1.

(2)referred to set 2.

Parameter descriptions

SP1 = Operation order of relay 1. Specifies the ON/OFF point of relay 1. Variable between r4 and r6.

SP2 = Operation order of relay 2. Specifies the ON/OFF point of relay 2. Variable between r5 and r7.

r0 = Dependency between SP1 and SP2. Only for mode ONOFF1

ind = order for relay 2, SP2.

dep = order for relay 2, SP1+SP2.

r1 = Differential or hysteresis for relay 1. Temperature differential between ON/OFF of relay 1 in ON/OFF control.

r2 = Differential or hysteresis for relay 2. Temperature differential between ON/OFF of relay 2 in ON/OFF control.

r3 = Band differential. Temperature differential between ON/OFF of relays 1 and 2 in neutral area control. For relay 1 it is added to SP1 and for relay 2 it is subtracted from SP1.

r4 = Lowest value for SP1.

r5 = Lowest value for SP2.

r6 = Highest value for SP1.

r7 = Highest value for SP2.

r8 = Regulation or operating mode. Selection of the operating mode.

A0 = Alarm differential. It is the temperature differential between the alarm On and Off cycle.

A1 = Maximum alarm probe1.

A2 = Maximum alarm probe2.

Maximum alarm ON when probe 2 higher than SP2+A2

Maximum alarm OFF when probe 2 lower than SP2+A2-A0.

A3 = Minimum alarm probe1.

Minimum alarm ON when probe 1 lower than SP1-A3

Minimum alarm OFF when probe 1 higher than SP1-A3+A0.

A4 = Minimum alarm probe2.

Minimum alarm ON when probe 2 lower than SP2-A4

Minimum alarm OFF when probe 2 higher than SP2-A4+A0.

A5 = Alarm verification time. Time from the alarm event until it trips.

A6 = Alarm probe 1 selection.

AHL=Maximum and minimum alarm probe 1 enabled.

Ano=No alarms probe 1.

AH=Maximum alarm probe 1 enabled.

AL=Minimum alarm probe 1 enabled.

A7 = Alarm probe 2 selection.

AHL=Maximum and minimum alarm probe 2 enabled.

Ano=No alarms probe 2.

AH=Maximum alarm probe 2 enabled.

AL=Minimum alarm probe 2 enabled.

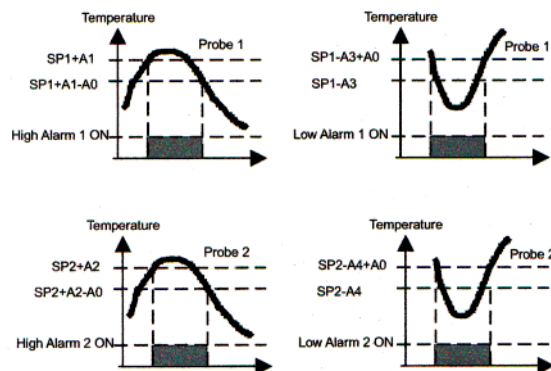

c0 = Minimum relay stop time. Minimum time from the disconnection of a relay until it can be switched on again.

c1 = Operation relay 1. Selection between direct or reverse operation for relay 1.

c2 = Operation relay 2. Selection between direct or reverse operation for relay 2.

c3 = Default operation relay 1. In case of failure of probe 1:

oPn= relay 1 will remain open.

Clo= relay 1 will remain closed.

c4 = Default operation relay 2. In case of failure of probe 1 (for all modes excepting ON OFF2) or in case of failure of probe 2 (for mode ON OFF2):

oPn= relay 2 will remain open.

Clo= relay 2 will remain closed.

P0 = Temperature scale selection.

P1 = Calibration of probe 1. Offset degrees to be added to probe 1.

P2 = Calibration of probe 2. Offset degrees to be added to probe 2.

P3 = Decimal point. If the displayed value of the probes is desired with decimals or not.

P4 = Probe to be displayed. Probe always on the display. The other probe can be seen pressing the keys SET+UP.

sd1= probe 1.

sd2= probe 2.

P5 = Number of probes. If P5=1, there is not ON OFF2 mode. If selected, it will operate as ONOFF1.

H0 = Reprogramming. Parameter to reprogram the thermostat.

H1 = Keyboard protection.

To change the sets, enter into parameter and exit again. The protection setting is momentarily released. It switches on again 1 minute after the last time a key was pressed.

Yes= Keyboard Protected.

No=Keyboard non protected.

H2 = Operation of LED OUT1.

dir = On when relay 1 is ON.

inv = On when relay 1 is OFF.

H3 = Operation of LED OUT2.

dir = On when relay 2 is ON.

inv = On when relay 2 is OFF.

H4 = Serial communication address. Address for computer connection.

H5 = Parameter entry code. Factory set as 0.

H6 = Input probe type selectable between PTC or NTC.

Message display

Under normal operation, the temperature of the probe selected by P4 will be displayed, the following messages may also appear:

- Err** Memory reading error.
- ErP** Error of the probe not shown on the display.
- AH1** Maximum temperature alarm, probe 1.
- AL1** Minimum temperature alarm, probe 1.
- AH2** Maximum temperature alarm, probe 2.
- AL2** Minimum temperature alarm, probe 2.
- ooo** Open probe.
- **---** Shorted probe.

Pressing SET with UP it displays the probe not selected by P4.

When the probe not selected by P4 is displayed, it alternates its value with message Sd1 or Sd2 depending if it is probe 1 or probe 2.

The display blinks when waiting for a value confirmation.

LED indications

Out1: Indicates relay 1 On or Off as per parameter H2. If H2=dir, with relay 1 On, LED lit, if H2=inv, with relay 1 On, LED off. It blinks when SP1 is displayed.

Out2: Indicates relay 2 On or Off as per parameter H3. If H3=dir, with relay 2 On, LED lit, if H3=inv, with relay 2 On, LED off. It blinks when SP2 is displayed.

Setting SP1 and SP2

- Press and release SET. The current value of order 1 is displayed. SP1 and led OUT1 blink.
- Press UP or DOWN to increase or decrease the value.
- Press SET to confirm the new value. The actual value of order 2 will be displayed, SP2 and LED OUT2 blink.
- Press UP or DOWN to increase or decrease the value.
- Press SET to confirm the new value and exit.

Parameter setup

- Press SET for 8 seconds. Value 0 will blink.
- With UP and DOWN input the code (factory set as 0).
- Press SET to confirm the code. If correct, the label of the first parameter will be displayed.
- With UP or DOWN go to the desired parameter in the parameter list.
- Press SET to see the value.
- With UP or DOWN change the value to the new value as desired.
- Press SET to confirm and exit again to the parameter list. (Also to exit to the list without parameter modification.)
- Press SET + DOWN to exit setup or wait for 1 minute.

Resetting the keyboard code

You can setup to 0 the keyboard code switching the unit off and on while pressing the SET key.

Buzzer disconnection

Pressing SET with DOWN turns off the buzzer alarm. The message of alarm continue appearing in the display.

Reprogramming factory values (H0)

•Access to parameter H0 as explained in parameter setup.

•Value 0 will be displayed.

•Press SET for 8 seconds. Pro will be displayed if they have been setup correctly.

•Press SET + DOWN to exit setup or wait for 1 minute.

	Description	Factory value
SP1	Set Point 1	10.0
SP2	Set Point 2	10.0
r0	Dependency SP1 - SP2	ind
r1	Differential for SP1	1.0
r2	Differential for SP2	1.0
r3	Band differential 1.0	1.0
r4	Lower value for SP1	-99.9
r5	Lower value for SP2	-99.9
r6	Higher value for SP1	99.9
r7	Higher value for SP2	99.9
r8	Regulation or operating mode	On1
A0	Alarm differential	0.1
A1	Maximum alarm probe 1	99.9
A2	Maximum alarm probe 2	99.9
A3	Minimum alarm probe 1	99.9
A4	Minimum alarm probe 2	99.9
A5	Alarm verification time	18.0
A6	Alarm probe 1 selection	AHL
A7	Alarm probe 2 selection	AHL
c0	Minimum relay stop time	0
c1	Operation relay 1	dir
c2	Operation relay 2	dir
c3	Default operation relay 1	Opn
c4	Default operation relay 2	Opn
P0	Temperature scale selection	°C
P1	Calibration of probe 1	0.0
P2	Calibration of probe 2	0.0
P3	Decimal point	yes
P4	Probe to be displayed	sd1
P5	Number of probes	2
H0	Reprogramming	0
H1	Keyboard protection	no
H2	Operation LED OUT1	dir
H3	Operation LED OUT2	dir
H4	Address for serial communication	0
H5	Access code to parameters	0
H6	Probe type	Ptc

Operating modes

Mode ON OFF1 (On1) with r0=ind.

Relay 1 with c1=dir.

Temperature of probe 1 \geq SP1+r1 -->relay 1 ON
 Temperature of probe 1 \leq SP1 -->relay 1 OFF

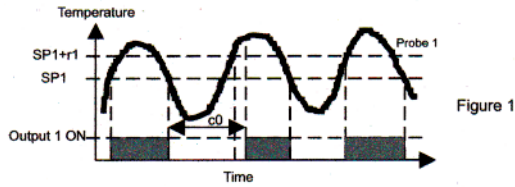

Relay 1 with c1=inv.

Temperature of probe 1 \leq SP1-r1 -->relay 1 ON
 Temperature of probe 1 \geq SP1 -->relay 1 OFF

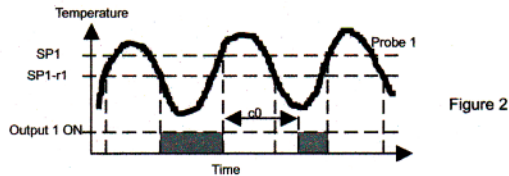

Relay 2 with c2=dir.

Temperature of probe 1 \geq SP2+r2 -->relay 2 ON
 Temperature of probe 1 \leq SP2 -->relay 2 OFF

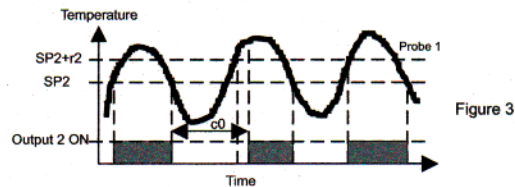

Relay 2 with c2=inv.

Temperature of probe 1 \leq SP2-r2 -->relay 2 ON
 Temperature of probe 1 \geq SP2 -->relay 2 OFF

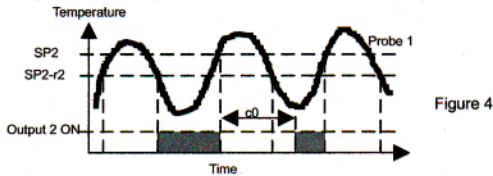

Mode ON OFF1 (On1) with r0=dep.

Output 1 works as in independent ON/OFF control (Figure 1 and 2), but output 2 works as follows:

Relay 2 with c2=dir.

Temperature of probe 1 \geq SP1+SP2+r2 -->relay 2 ON
 Temperature of probe 1 \leq SP1+SP2 -->relay 2 OFF

Relay 2 with c2=inv.

Temperature of probe 1 \leq SP1+SP2-r2 -->relay 2 ON
 Temperature of probe 1 \geq SP1+SP2 -->relay 2 OFF

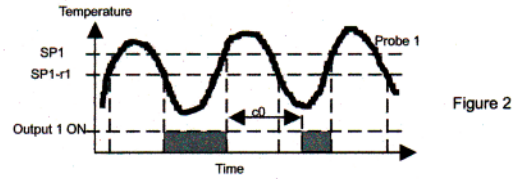

Mode ON OFF2 (On2)

Output 1 works as in independent ON/OFF control (Figure 1 and 2), but output 2 works as follows:

Relay 2 with c2=dir.

Temperature of probe 2 \geq SP2+r2 -->relay 2 ON
 Temperature of probe 2 \leq SP2 -->relay 2 OFF

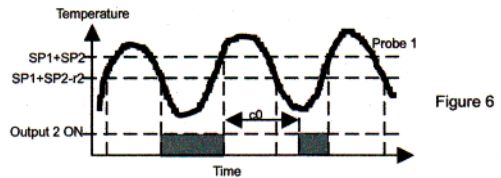

Relay 2 with c2=inv.

Temperature of probe 2 \leq SP2-r2 -->relay 2 ON
 Temperature of probe 2 \geq SP2 -->relay 2 OFF

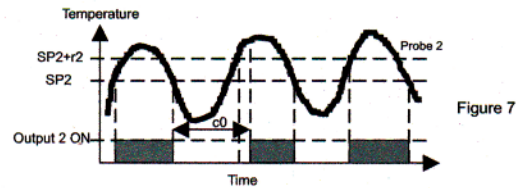

Neutral Area Mode (nEU)

Relay 1

Temperature of probe 1 \geq SP1+r3 -->relay 2 ON
 Temperature of probe 1 \leq SP1 -->relay 2 OFF

Relay 2

Temperature of probe 1 \leq SP1-r3 -->relay 2 ON
 Temperature of probe 1 \geq SP1 -->relay 2 OFF

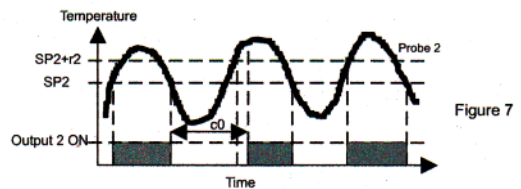

Operation in case of error.

If probe 1 fails, the operation is through c3. (See Parameter description.)

If probe 2 fails, the operation is through c4. (See Parameter description.)

In case of memory failure, both relays will remain open.

MODERATE WIRING DIAGRAM W/OPTIONAL RECORDER

